

WALCHEM

An Iwaki America Company

WEL Series pH/ORP ELECTRODES Instruction Manual

Five Boynton Road
TEL: 508-429-1110

Hopping Brook Park
FAX: 508-429-7433

Holliston, MA 01746
Web: www.walchem.com

Five Boynton Road
TEL: 508-429-1110

Hopping Brook Park
FAX: 508-429-7433

Holliston, MA 01746
Web: www.walchem.com

Notice

© 2010 WALCHEM, An Iwaki America Incorporated Company (hereinafter "Walchem")
5 Boynton Road, Holliston, MA 01746 USA
(508) 429-1110
All Rights Reserved
Printed in USA

Proprietary Material

The information and descriptions contained herein are the property of WALCHEM. Such information and descriptions may not be copied or reproduced by any means, or disseminated or distributed without the express prior written permission of WALCHEM, 5 Boynton Road, Holliston, MA 01746.

This document is for information purposes only and is subject to change without notice.

Statement of Limited Warranty

WALCHEM warrants equipment of its manufacture, and bearing its identification to be free from defects in workmanship and material for a period of 24 months for electronics and 12 months for mechanical parts and electrodes from date of delivery from the factory or authorized distributor under normal use and service and otherwise when such equipment is used in accordance with instructions furnished by WALCHEM and for the purposes disclosed in writing at the time of purchase, if any. WALCHEM's liability under this warranty shall be limited to replacement or repair, F.O.B. Holliston, MA U.S.A. of any defective equipment or part which, having been returned to WALCHEM, transportation charges prepaid, has been inspected and determined by WALCHEM to be defective. Replaceable elastomeric parts and glass components are expendable and are not covered by any warranty.

THIS WARRANTY IS IN LIEU OF ANY OTHER WARRANTY,
EITHER EXPRESS OR IMPLIED, AS TO DESCRIPTION,
QUALITY, MERCHANTABILITY, FITNESS FOR ANY P
ARTICULAR PURPOSE OR USE, OR ANY OTHER MATTER.

P/N 180109.J3
Jan 2010

1.0 Operation

The number of parts required and the installation will vary with the model ordered. The electrode consists of a replaceable pH or ORP electrode cartridge, an electrode housing which may also contain a temperature compensation element and/or a reliable differential - type preamplifier with solution ground, and a mounting nut and adapter for in-line mounted models.

Electrode Cartridges:

There are four pH electrode cartridge choices. Each is best suited for specific applications:

WEL-PHF-NN is a flat surface glass pH electrode which will function well in almost any application, and will perform especially well if the solution tends to coat an electrode with solids or oils.

WEL-PHB-NN is a bulb-type glass pH electrode which will function well in clean chemical applications.

WEL-PHH-NN is a flat surface glass pH electrode which is highly resistant to attack by acidic fluoride solutions that would quickly etch the glass of a standard pH electrode.

WEL-PHLI-NN is a flat surface glass pH electrode with a special gel suitable for use in low ionic strength water, with conductivity between 10 and 100 μ S/cm.

There are two choices of ORP electrode cartridge.

The WEL-MVF-NN is a flat surface platinum electrode which will work in almost any application.

The WEL-MVR-NN uses a platinum rod and is used where the oxidizer level is below 0.25 mg/l.

Electrode Housings:

There are six housings available, which are selected based upon the type of electrode cartridge used, and the type of instrument to be connected:

The 102581 housing contains a Pt1000 automatic temperature compensation (ATC) element and differential preamplifier with solution ground. This housing is specified in pH applications when the error due to changing temperature is significant to your process (see table below), and the instrument that the electrode will connect to either does not have an integral preamplifier (such as the WPH or WNI series) or if the distance between the instrument and the electrode will exceed 20-30 feet. It should not be specified for ORP applications, since no ATC is used. It is supplied with a 20 ft. cable with tinned leads.

The 102758 housing is identical to the 102581 housing except it uses a Pt100 ATC element.

The 102606 housing contains only the differential preamplifier with solution ground, and does NOT contain the Pt1000 ATC element. This housing is specified when the error due to temperature is insignificant to your process, and the instrument you will attach does not have a preamplifier in it (such as the WPH or WNI series), or is more than 20-30 feet away. It would also be used with an ORP cartridge, since there is no ATC used in ORP applications. It is supplied with a 20 ft. cable with tinned leads.

The 102582 housing contains only the Pt1000 ATC element with solution ground, but does NOT contain the preamplifier. This is used in pH applications where the error due to temperature is significant to your process, and the instrument to be attached contains an integral preamplifier (such as the W-250/260 or W-130/230 series), and will be located within 20-30 feet of the electrode. It should not be used in ORP applications. It is supplied with a 20 ft. cable with a BNC connector for the pH signal and tinned leads for the ATC and solution ground signals.

The 102759 housing is identical to the 102582 housing except it uses a Pt100 ATC element.

The 102607 housing contains neither an ATC element, nor the preamplifier. It should be used in pH or ORP applications where the error due to temperature is insignificant to your process, and the instrument to be attached contains an integral preamplifier (such as the W-250/260 or W-130/230 series), and will be located within 20-30 feet of the electrode. It is supplied with a 20 ft. coax cable with a BNC connector.

pH Temperature Error Table:

°C	2	3	4	5	6	7	8	9	10	11	12
5	.30	.24	.18	.12	.06	0	.06	.12	.18	.24	.30
15	.15	.12	.09	.06	.03	0	.03	.06	.09	.12	.15
25	0	0	0	0	0	0	0	0	0	0	0
35	.15	.12	.09	.06	.03	0	.03	.06	.09	.12	.15
45	.30	.24	.18	.12	.06	0	.06	.12	.18	.24	.30
55	.45	.36	.27	.18	.09	0	.09	.18	.27	.36	.45
65	.60	.48	.36	.24	.12	0	.12	.24	.36	.48	.60
75	.75	.60	.45	.30	.15	0	.15	.30	.45	.60	.75
85	.90	.72	.54	.36	.18	0	.18	.36	.54	.72	.90

Mounting Adapters:

For in-line applications, included will be the mounting adapter that fits into a standard 1/4" NPT tee, and the nut that secures the housing to the adapter.

For submersion applications, all that is required is a standard 1" NPTF threaded coupling and the appropriate length of 1" pipe. These parts are supplied by the user.

2.0 Installation

General Guidelines

Note: After removing the electrode from the soaker bottle, be sure to remove the large o-ring from the electrode. This o-ring prevents soaker solution from leaking out of the bottle and is not part of the electrode.

Instructions for mounting the electrode into the process solution will vary greatly with the type of electrode and the circumstances that are encountered in your application. Here are some general guidelines to assist you. Refer also to the typical installation drawings.

The electrode should be mounted such that the measuring surfaces will always stay wet. If the electrode dries out, it will respond slowly to changing pH/ORP values for 24 hours, and if dried out repeatedly, will fail prematurely.

For submersion applications, mount the electrode below the minimum solution level. If the tank will be completely drained, plan on removing the electrode and storing it in tap water (NOT DI water) or pH 4 buffer solution while the tank is empty. If this is undesirable, a recirculation loop may be installed and the electrode mounted in-line.

For in-line applications, where the electrode is installed in a pipe, the electrode should be placed on the discharge side of the pump (under positive pressure). A "U" trap should be installed so that if the flow stops, the electrode is still immersed in the solution. If the flow through the pipe can not be stopped to allow for cleaning and calibration of the electrode, then the electrode should be placed in a by-pass line with isolation valves to allow for electrode removal. Install the electrode vertically, with the measuring surface pointing down, at least 5 degrees above horizontal. (Refer to Installation drawings)

The electrode should be installed in an area where there is good solution movement and where it will respond rapidly to chemical additions. The placement of the electrode relative to the placement of chemical replenishment, along with the quality of the mixing, and the replenishment pump flow rate are all critical to accurate process control.

WPH Submersion Installation

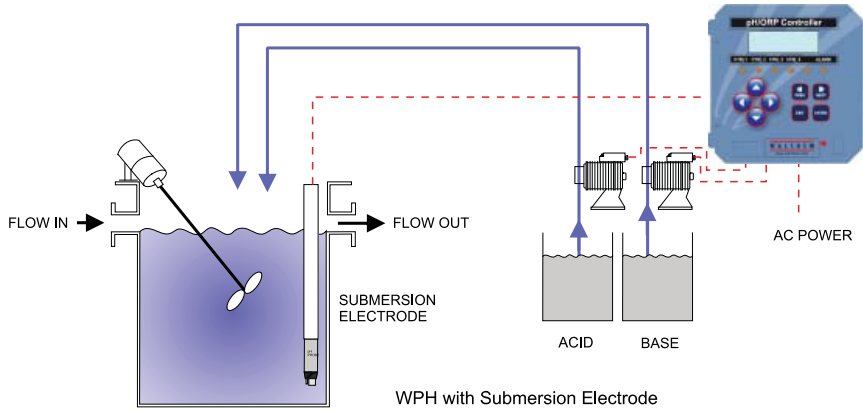

Electrode Assembly

For submersion applications, attach the threaded end of the housing to a 1" NPTF coupling and appropriate length of 1" pipe. This should be sealed to prevent the solution from contacting the electrode housing cable. Remove the protective cap from the end of the electrode cartridge, and thread the cartridge into the housing until it is hand tight. The o-ring should seat against the housing.

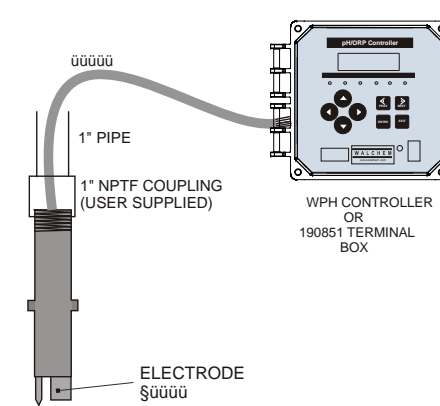

ELECTRODE HOUSING WITH PREAMP SUBMERSION MOUNT

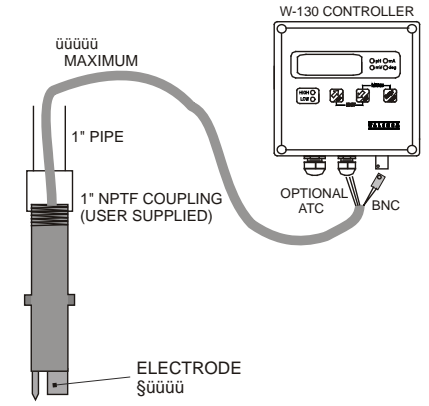

ELECTRODE HOUSING WITHOUT PREAMP SUBMERSION MOUNT

WPH In-line Installation

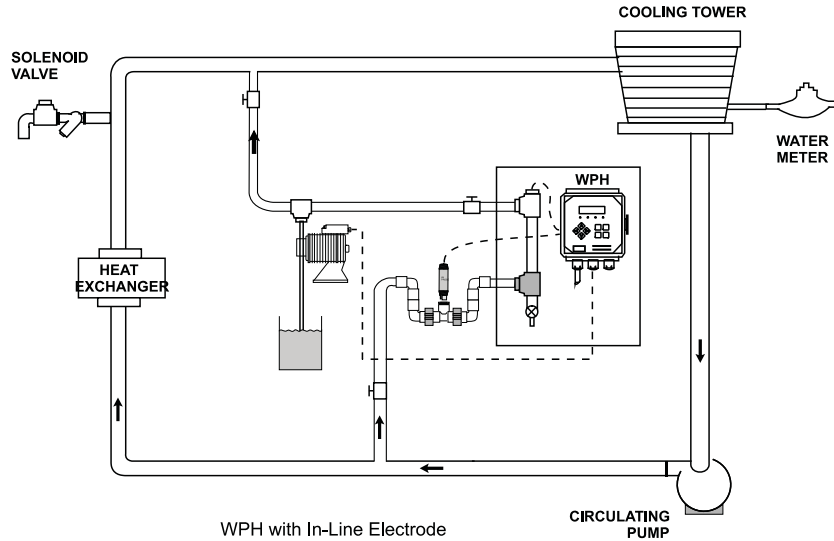

For in-line applications, feed the electrode housing cable through the adapter nut. Remove the protective cap from the end of the electrode cartridge, and thread the cartridge into the housing until it is hand tight. The o-ring should seat against the housing. Place the large o-ring into the mounting adapter groove, then place the electrode housing into the tee, and thread the adapter nut onto the tee until it is hand tight.

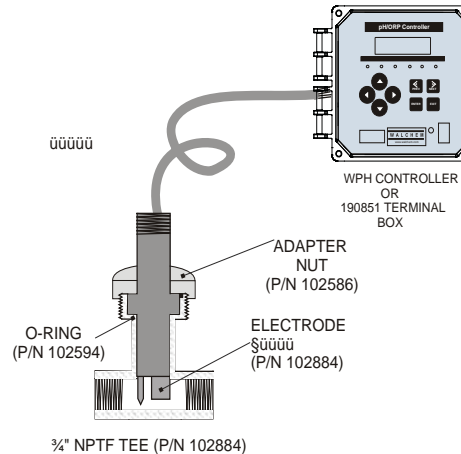

ELECTRODE HOUSING WITH PREAMP IN-LINE MOUNT

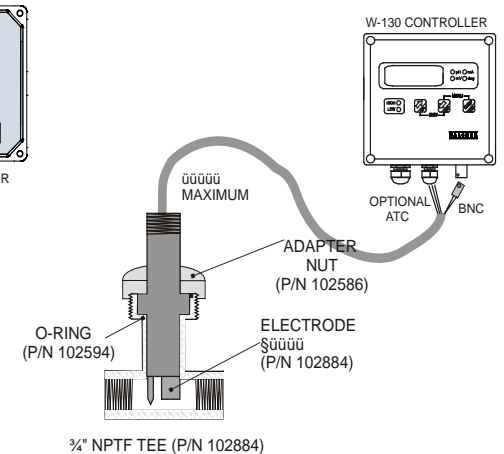

ELECTRODE HOUSING WITHOUT PREAMP IN-LINE MOUNT

Wiring Instructions

For housings that contain the integral preamplifier, attach the 7-conductor cable directly to the controller:

Drain:	Earth Ground
Orange:	VpH (pH +)
Wht w/Orn stripe:	Com (pH -)
Green:	TC +(optional) TC= Temperature Compensation
Wht w/Grn stripe:	TC - (optional)
Blue:	+5 VDC
Wht w/Blu stripe:	- 5 VDC

If the required cable length exceeds the 20 feet that is supplied, wire the housing to a 190851 terminal box, then use p/n 102535 cable to reach the instrument.

For housings that do not contain the integral preamplifier, attach the male BNC connector on the housing to the female BNC connector on the instrument, and the optional temperature wires to the temperature input terminal strip on the instrument:

Grn:	Earth Ground
Red	TC (polarity not critical for TC)
Blk:	TC (polarity not critical for TC)
	[TC= Temperature Compensation]

The non-amplified signal is extremely sensitive! Never cut, splice or otherwise harm the integrity of the coaxial cable or BNC connector! If the distance between electrode and instrument exceeds 20 feet, use the housing that contains a preamplifier, or purchase an externally mounted preamplifier.

Wiring to a WNI411/WDT410 Series Controller

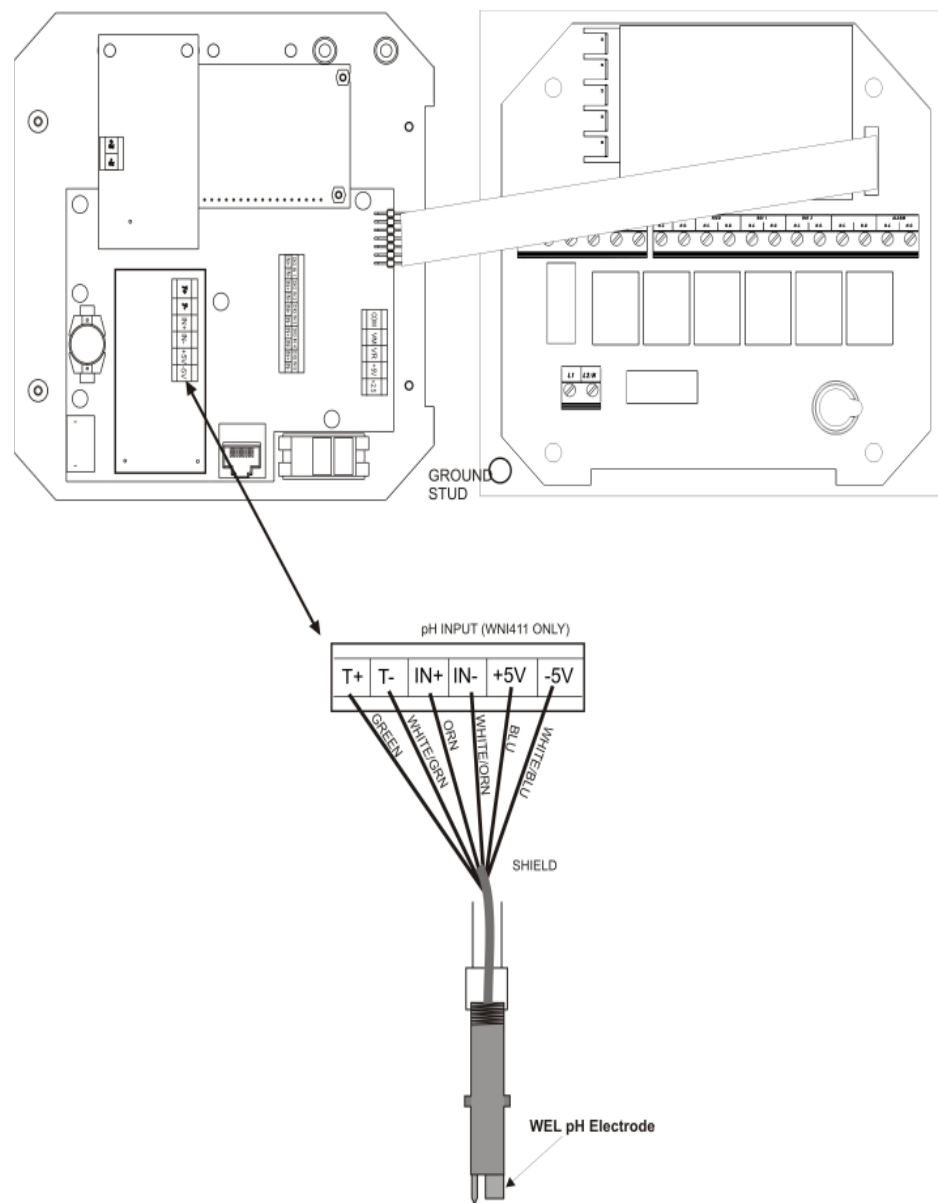

Wiring to a WPH/WDP400 Series Controller

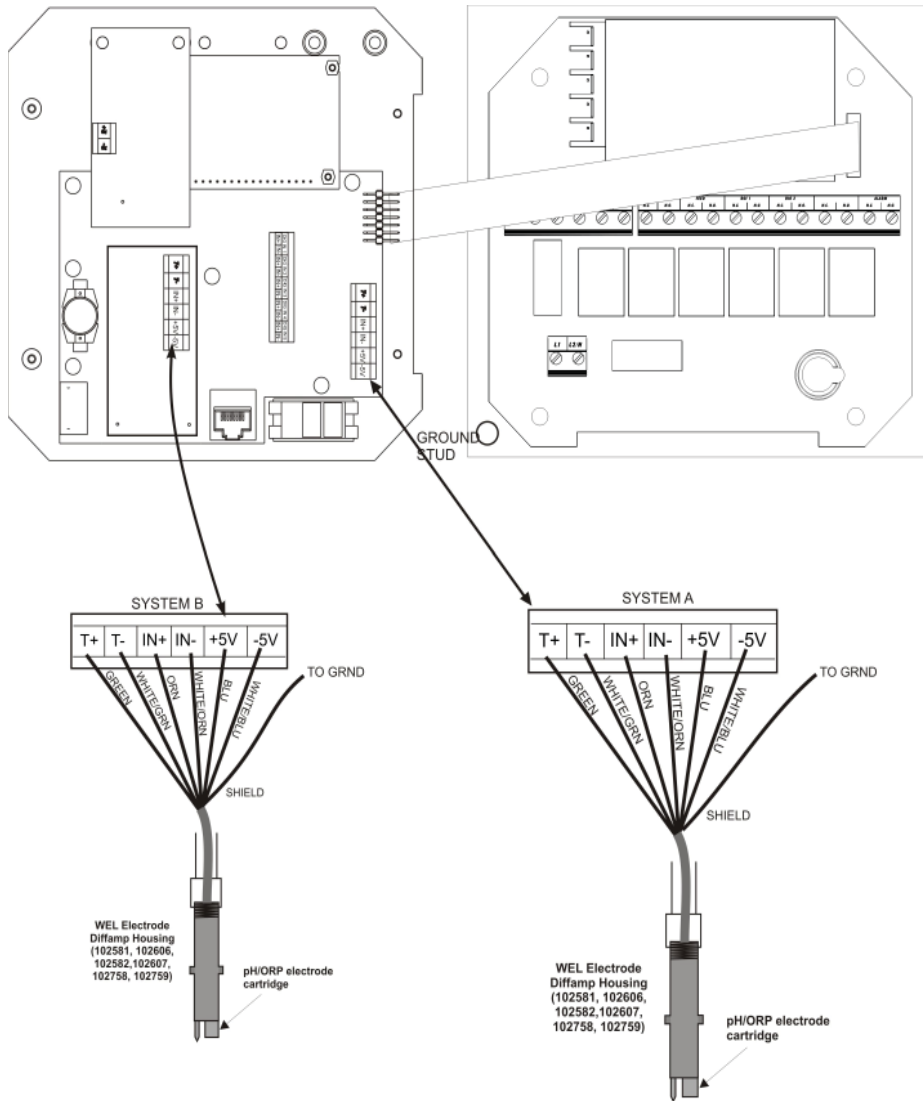

3.0 Maintenance

The Combination pH/Reference Electrode or ORP (REDOX) Reference Electrode is ruggedly made and easy to use. Because the pH responsive glass bulb or flat surface is relatively thin, care should be taken so that the bulb does not become scratched or broken. It is also important that ORP measuring surfaces are not scratched or gouged. The suggestions in this sheet are intended to help avoid these problems.

The built-in sealed reference design of this electrode eliminates the need to add filling solutions and minimizes reference dryout. This design feature also allows the electrode to be used in pressurized systems (refer to specification sheets or consult the factory for maximum pressure/temperature limit information).

Important Considerations

1. The pH Electrode is shipped in a plastic bottle or cap containing a solution of 4 buffer and potassium chloride. ORP (REDOX) Electrodes are shipped in caps containing a piece of cotton wetted with tap water. The electrode should remain in the bottle or cap until it is used. If the electrode is used infrequently, the bottle or cap and its solution should be saved and the electrode stored in it.
2. Electrodes are a form of a battery and have limited shelf lives. Electrodes in inventory should be rotated so that older electrodes are used first.
3. Vigorous stirring brings a sample, buffer or rinse solution to the measuring surface more quickly and will improve speed of response. Care must be taken to keep the electrode's measuring surface from striking a surface and getting scratched or broken.
4. After exposure to a sample, buffer or rinse solution, carryover can be minimized by blotting - never by wiping - the electrode with a clean, non-abrasive paper or a clean cloth towel.
5. As a rinse solution, use a part of the next sample or buffer which is to be measured. This action also will minimize contamination from carryover.
6. When calibrating, use a buffer close in value to that expected from the sample for 1 point calibrations or as the first buffer for 2 point calibrations (see below). This action will minimize span errors.
7. Readings stabilize faster in some solutions than others; allow time for the reading to stabilize. In general, with new electrodes stable readings in buffers are obtained in 10-15 seconds.
8. All pH electrodes age with time. Aging is characterized by shortened span and slower speed of response. Aging is best detected by the 2 point calibration method. If the pH meter has manual or microprocessor slope (span) controls, the controls can be adjusted to compensate for electrode span errors (but will not affect the speed of the response).

9. Electrodes should be replaced when their readings cannot be corrected by the meter's controls and/or when their speed of response is too slow for the application for which they are being used. The frequency of electrode replacement is a function of the application; electrodes operating in hot liquids at very high or very low pH values will have shorter lives than those operating at neutral pH and ambient temperature.
10. Coatings on an electrode's surface prevent new liquids from contacting an electrode's measuring surface and can mimic the effects of electrode aging. Before concluding that an electrode needs replacing, check the surface for coatings.
11. Temperature affects electrode readings in two ways. First, the output of an electrode varies with temperature. For pH electrodes this effect can be corrected by manual or automatic temperature compensation (ORP/REDOX readings are not correctable for the effect of temperature changes). Second, the real pH or ORP value, independent of the electrode measuring the value or the use of temperature compensation, is temperature dependent. This fact means, for example, that the readings at 25°C and 75°C will be (and, in fact are) different.

CALIBRATION

As a rule, follow the procedure shown in the pH Meter's Instruction Manual. These procedures will vary depending on whether the meter is a simple type with manual adjustments, a micro-processor type or a pH transmitter.

FREQUENCY OF CALIBRATION

The frequency of calibration is a function of many factors. These factors include:

1. The accuracy required by the application.
2. The value of the off-specification product versus the cost of calibration.
3. The coating or abrasive nature of the application.
4. The stability of the pH Electrode and pH Meter as a system.

The frequency of calibration is really determined by experience. At a new installation, calibration might initially be checked every few hours or shift with the calibration changes noted in a log. As a pattern of longer stability is found, the time between calibration checks can be increased to once a day or once a week. Although the frequency of calibration is solely the responsibility of the user, once a week is the longest recommended interval between calibrations.

SYSTEM CALIBRATION CONCEPTS

The pH Electrode and the pH Meter should always be calibrated as a system. Electronic calibration of a pH Meter with a pH signal simulator checks the meter only and does not correct for imperfections of the pH Electrode. Even if perfect when new, the performance of pH electrodes varies with time, usually in an unpredictable way. When changing electrodes or connecting an electrode to a different pH meter, re-calibration must be performed.

SINGLE POINT CALIBRATIONS

Single point calibrations involve the use of one pH buffer. They are the easiest to make but can provide misleading results. They should only be used for quick checking from time to time.

TWO POINT CALIBRATIONS

As their name implies, 2 point calibrations use 2 pH buffers: for example, buffers 7.00 and 4.00 or buffers 7.00 and 10.00. Two point calibrations correct for the pH electrode's offset and span errors. Since both the offset and span vary with time, the 2 point method is the preferred one.

GRAB SAMPLE CALIBRATIONS

The Grab Sample Calibration method is used when it is difficult or undesirable to remove an electrode from a system. This method involves obtaining a sample of the liquid being measured and noting the meter's reading at that time. The sample's reading is obtained by use of a calibrated lab or portable meter and that reading is compared to that of the on-line meter. The on-line meter is adjusted by the difference between the readings. It is important to use the difference between the readings because the system's reading may have changed in the intervening time. It is important that the sample being measured by the lab meter be at the process temperature or erroneous results may occur (See #11 on the previous page).

CALIBRATION PROCEDURES

Stepwise calibration procedures are noted in the pH Meter's Instruction Manual. The following suggestions will help make calibrations as accurate as possible:

1. Before placing the electrode in a new buffer, use an absorbent paper towel or clean absorbent cloth to blot, not wipe, off any liquid that clings to the electrode. This action will minimize carry-over that could contaminate the buffer.
2. Always use fresh buffers. Safely dispose of the buffers after they have been used for calibration. Do not return them to their bottles; this action could contaminate the buffers.
3. Stir the electrode in the buffer to make certain that the fresh buffer quickly reaches the electrode's measuring surface.

INTERMITTENT OPERATION

Some facilities are only operated part of the time. When out of operation, electrodes must not be allowed to be exposed to air and become dry. Electrodes should be removed from such systems and stored in their bottles and caps or in a beaker, filled, preferably with 4 buffer. In some instances, power to the meter is shut off; this condition can be harmful to the electrodes. Electrodes should be disconnected from un-powered meters.

ELECTRODE CLEANING

Coating of an electrode's measuring surface can lead to erroneous readings including shortened span and slow response times. The type of coating determines the type of cleaning technique.

Soft coatings can be removed by vigorous stirring, by use of a squirt bottle, or very carefully, by gently wiping with a soft, clean non-abrasive paper or cloth. Hard coatings should be chemically removed. The chemical used to remove the coating should be the least harsh chemical that dissolves the coating in 1 or 2 minutes and does not attack the electrode's materials of construction. For example, a calcium carbonate coating might be removed with 5% HCl (muriatic acid).

Oily or organic coatings are best removed with detergents or an appropriate solvent that does not attack the electrode's materials of construction. For example, isopropyl alcohol might be used but acetone should be avoided if the electrode's body is made of CPVC.

Note: When using chemicals or solvents, care should be taken and appropriate eye, face, hand, body and/or respiratory protection should be used.

Never abrade or sand a pH electrode's surface. However, the measuring surface of an ORP/REDOX electrode may be gently abraded by use of 600 grade wet silicon carbide paper, jewelers rouge or very fine steel wool.